

BLOKEEN ERREPASO ARIKETAK

1

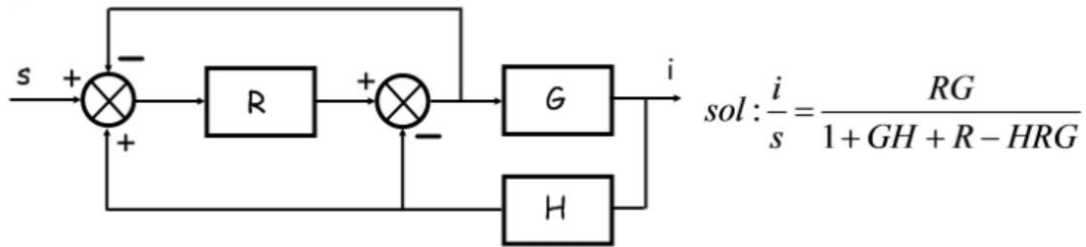

2

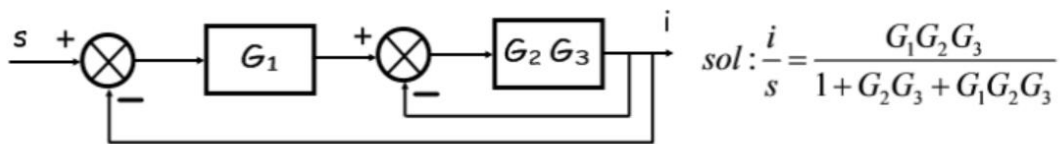

4

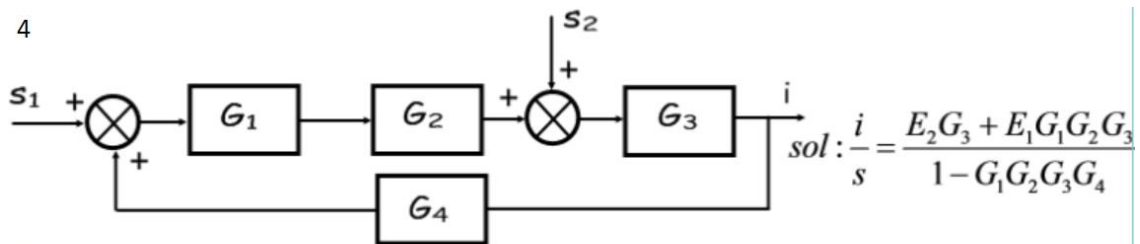

5

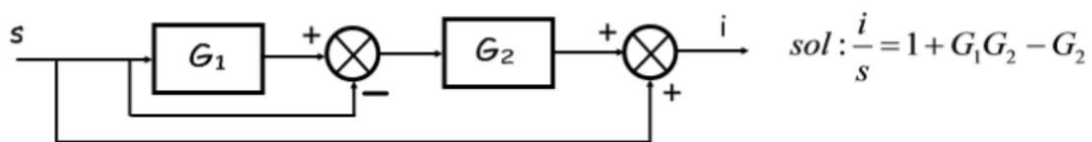

6

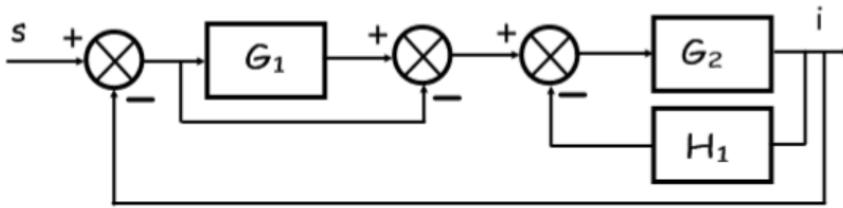

$$\text{sol: } \frac{i}{s} = \frac{(G_1 - 1)G_2}{1 + G_2H_1 + (G_1 - 1)G_2}$$

7

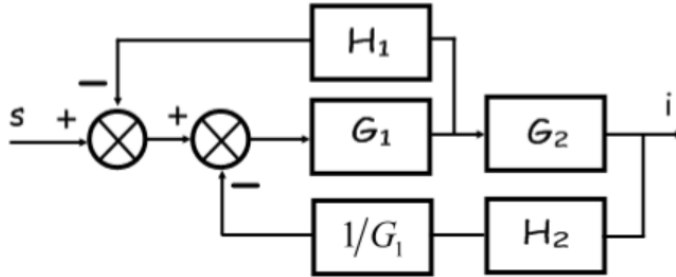

$$\text{sol: } \frac{i}{s} = \frac{G_1G_2}{1 + G_1H_1 + G_2H_2}$$

8

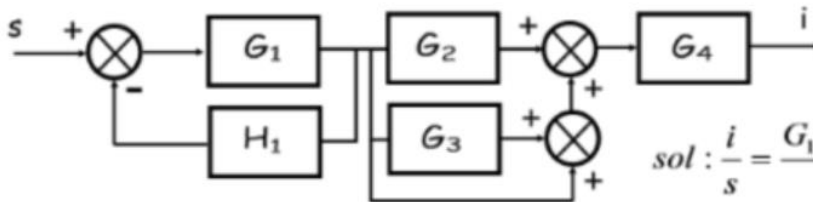

$$\text{sol: } \frac{i}{s} = \frac{G_1G_4 \cdot (G_2 + G_3 + 1)}{1 + G_1H_1}$$

9

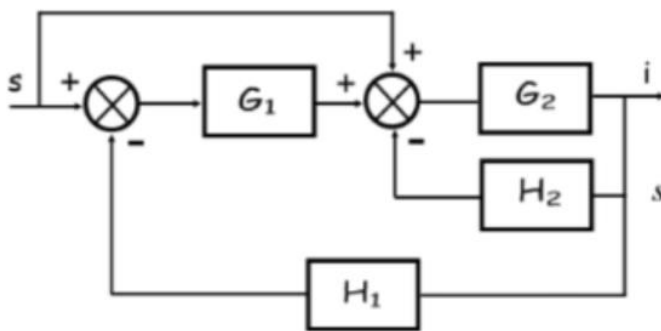

$$\text{sol: } \frac{i}{s} = \frac{G_2 \cdot (G_1 + 1)}{1 + G_2H_2 + G_1G_2H_1}$$

10

